

Nominal data

Type	605 F	
Nominal voltage	VDC	5
Nominal voltage range	VDC	4.5 .. 5.2
Speed	min ⁻¹	4000
Power input	W	1.1
Min. ambient temperature	°C	-20
Max. ambient temperature	°C	50
Air flow	m ³ /h	29
Sound power level	B	4.4
Sound pressure level	dB(A)	27

ml = Max. load · me = Max. efficiency · fa = Running at free air · cs = Customer specs · cu = Customer unit
Subject to alterations

Technical features

Mass	0.030 kg
Dimensions	60 x 60 x 15 mm
Material of impeller	Fiberglass-reinforced PA plastic
Housing material	Fiberglass-reinforced PBT plastic
Direction of air flow	Air exhaust over bars
Direction of rotation	Left, looking at rotor
Bearing	Sintec sleeve bearing
Lifetime L10 at 20 °C	50000 h
Lifetime L10 at 60 °C	20000 h
Connection line	Single strands AWG 28, TR 64, bared and tin-plated.
Motor protection	Protected against reverse polarity and locking.
Locked-rotor protection	Impedance protection
Approval	VDE, CSA, UL, CE
Option	Special options: Speed signal Go / No-go alarm PWM control input Moisture protection

605 F

DC axial compact fan

Product drawing

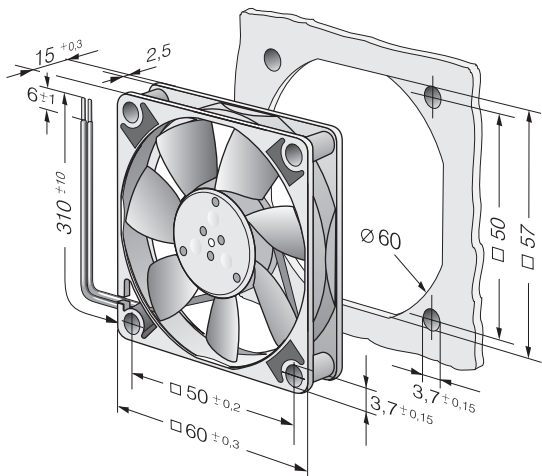

Charts: Air flow

